

DRAKTÄNDER

BARRICADE «DENTS DE DRAGON»



ZBEUL

**NOTICE
DE MONTAGE**

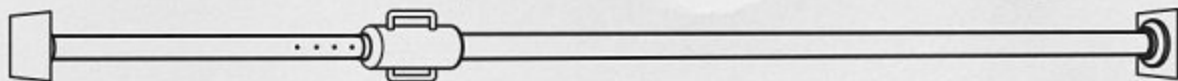
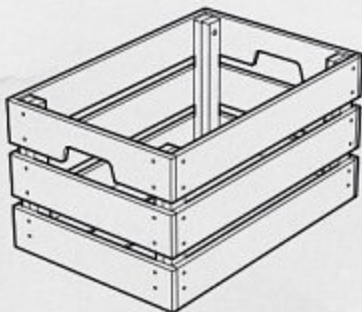
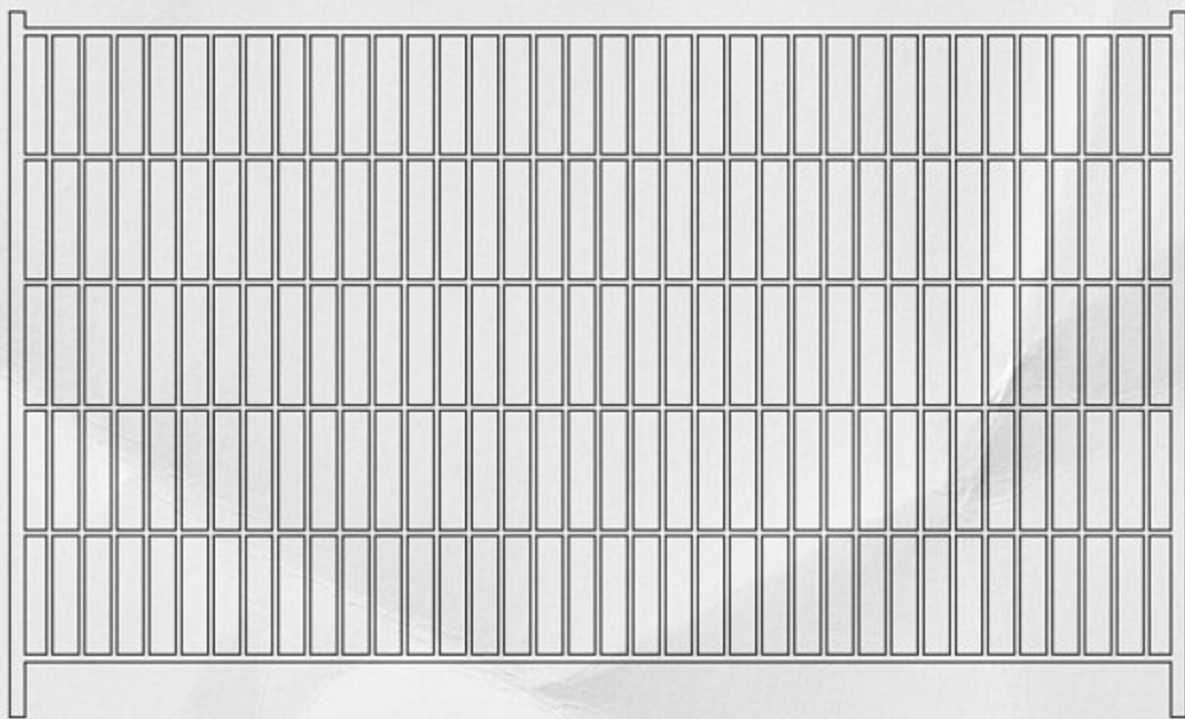
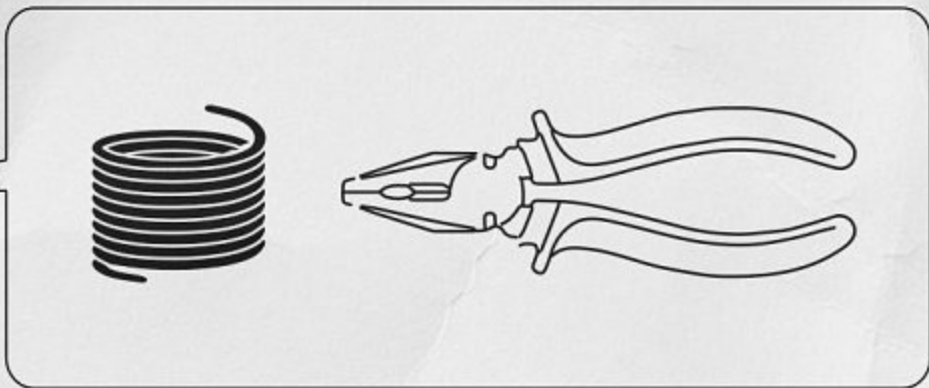

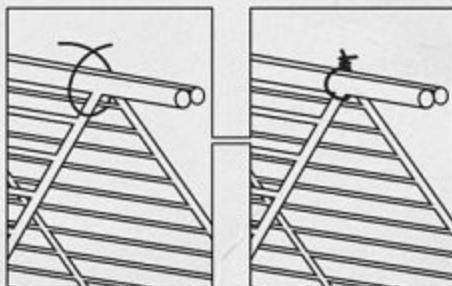
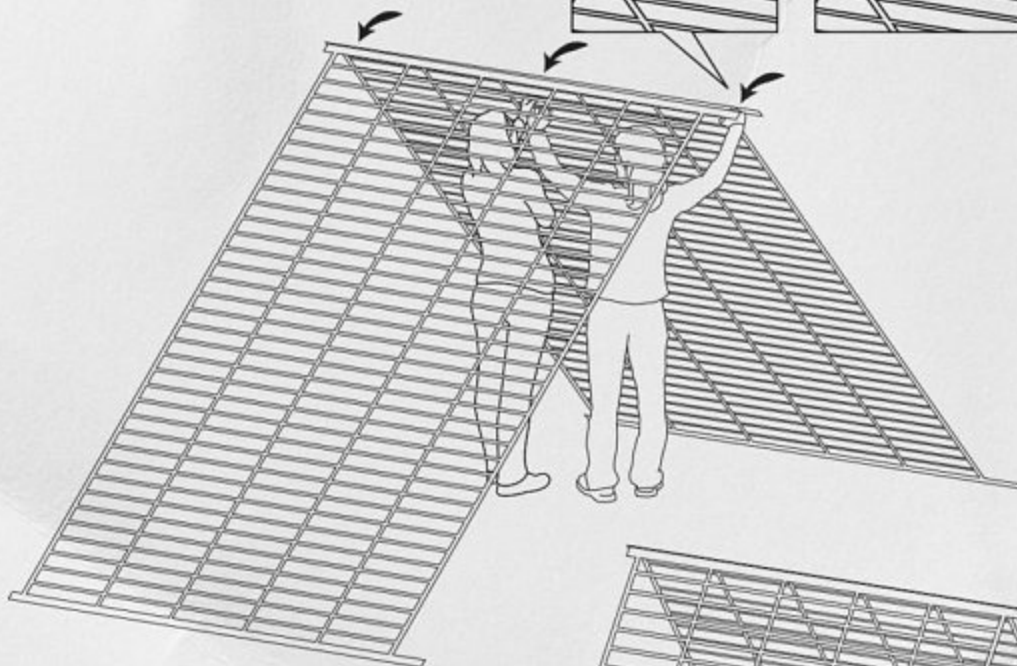
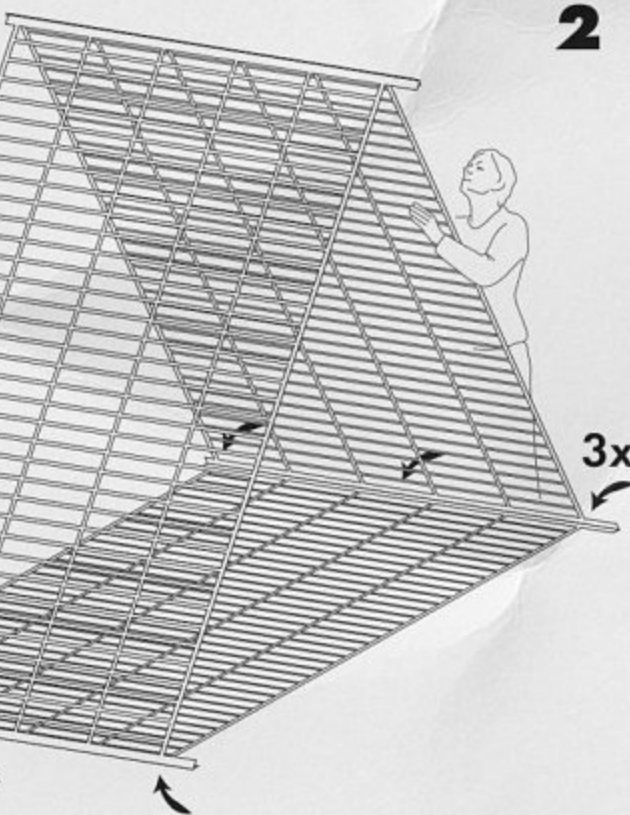
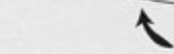
1**3x****2****3x****3x****3x**

3

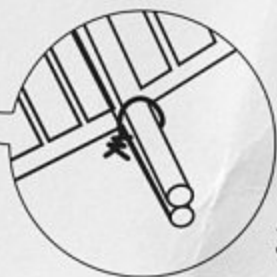
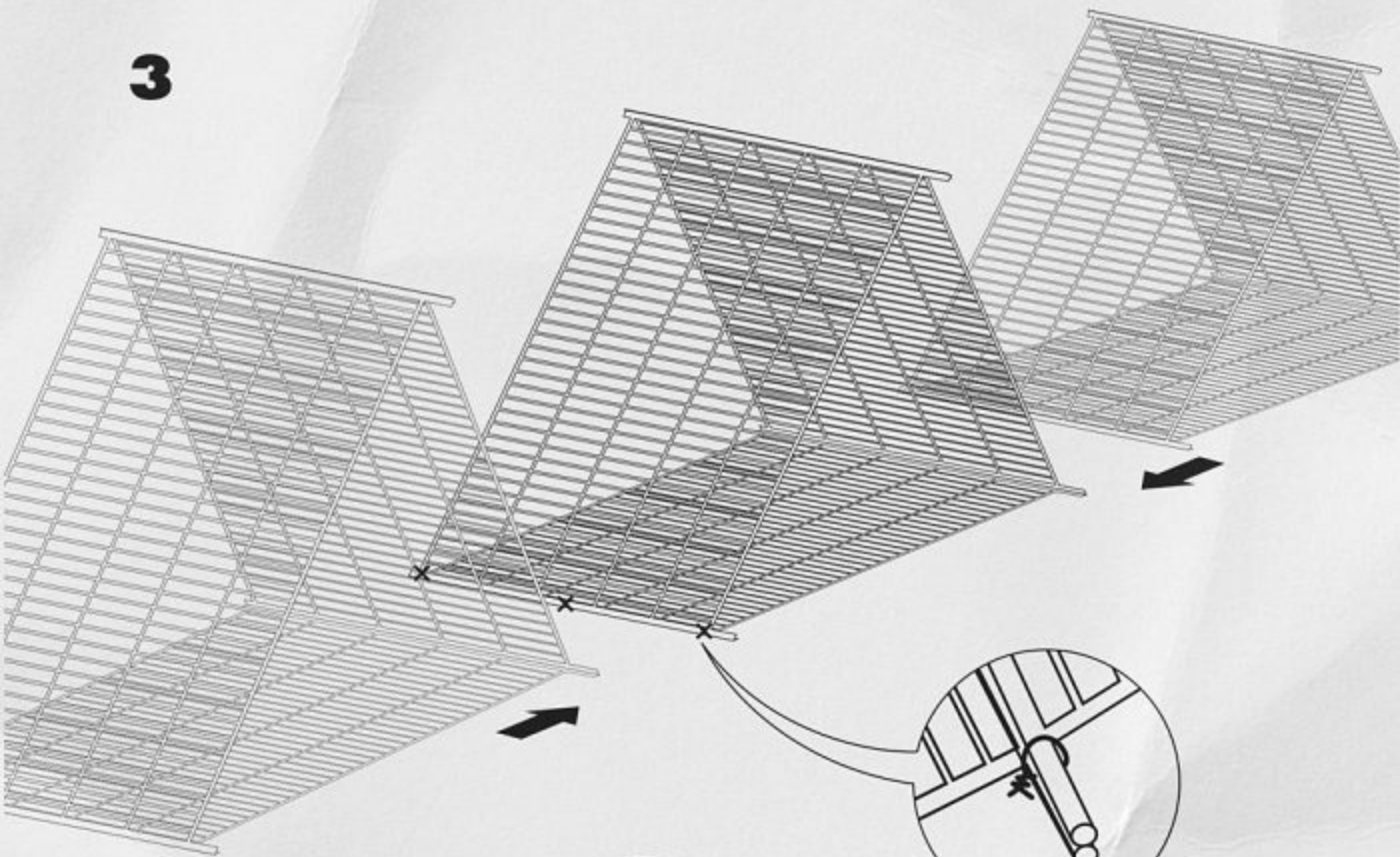

3x



3bis

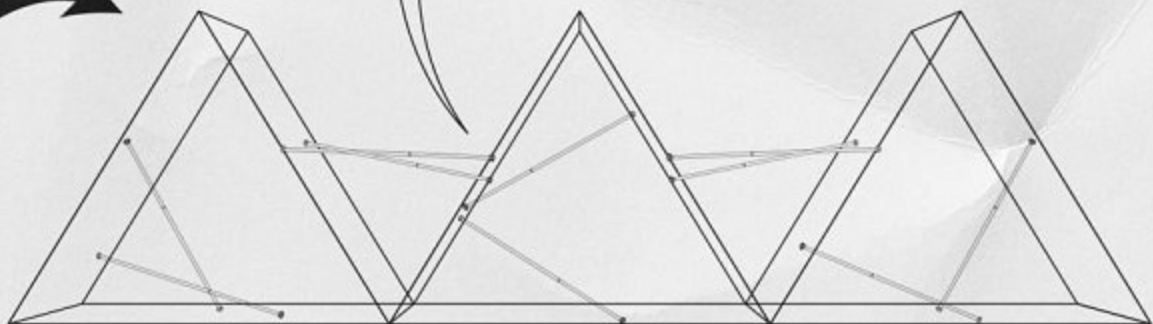

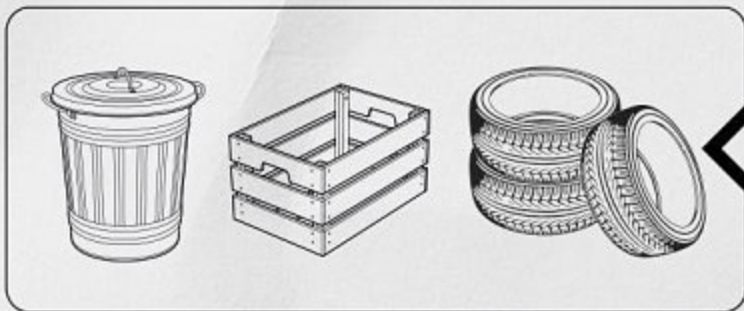

4

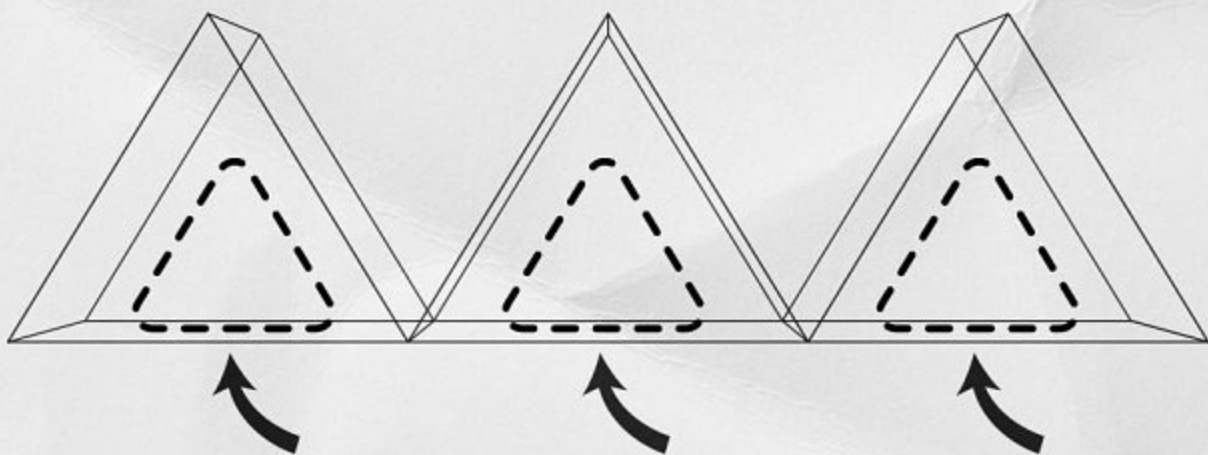
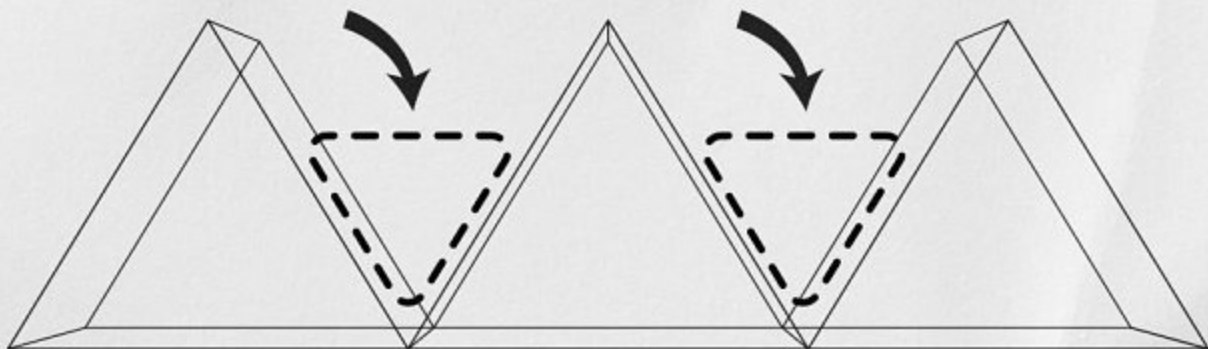

5

